

# TOP VIEW

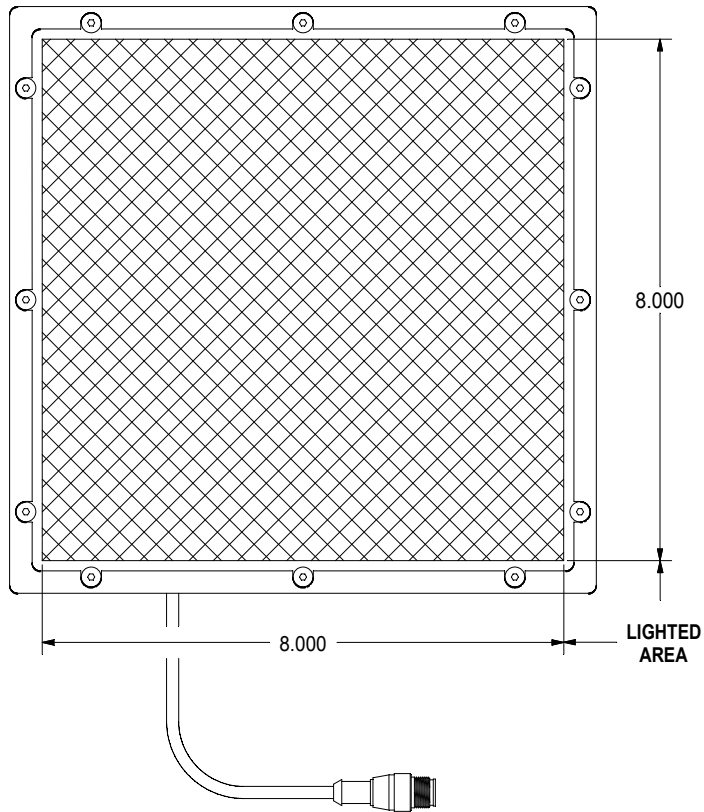

# BOTTOM VIEW

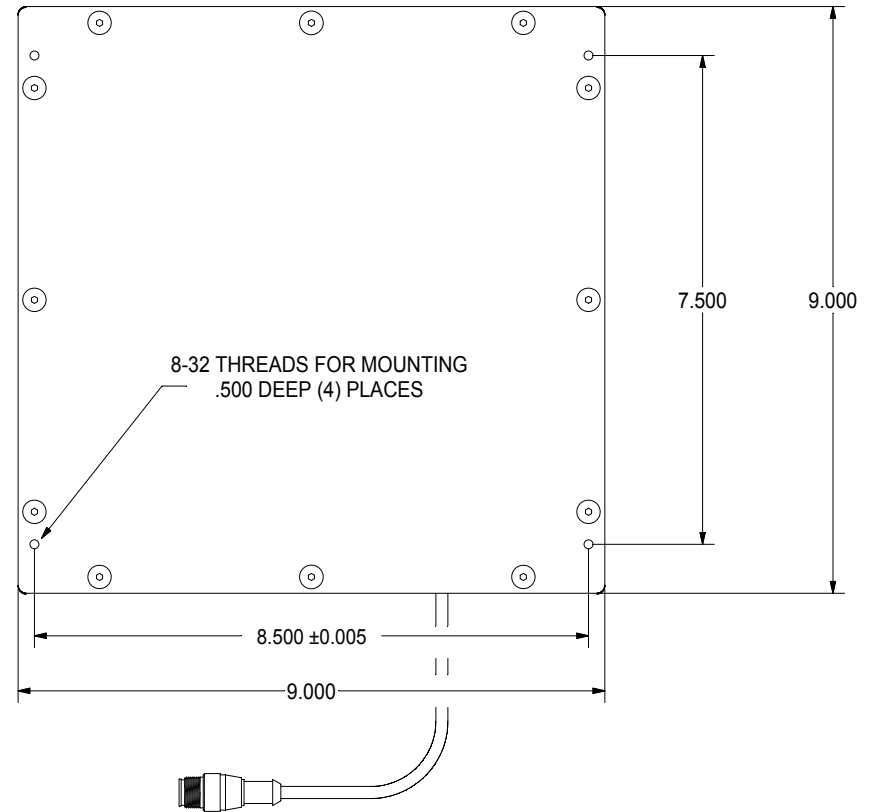

# SIDE VIEW

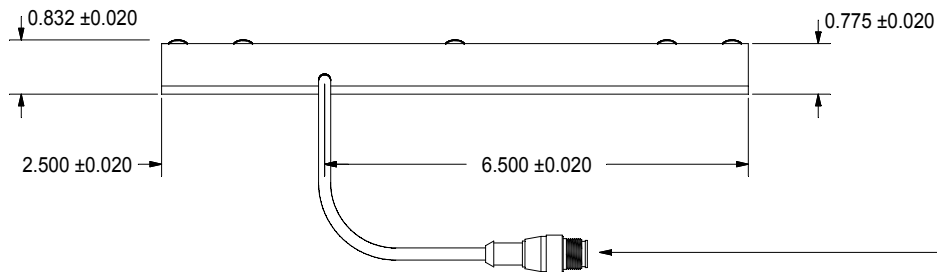

## STANDARD EUROFAST 4-PIN (MALE) CONNECTOR

*PIN 1 (+24VDC / BROWN)*

*PIN 3 (GROUND / BLUE)*

*PIN 4 (+24VDC / BLACK) STROBE/CONT.*

# BL88 MOUNT SPECIFICATIONS